

A BOOST DC - AC CONVERTER: OPERATION, ANALYSIS, CONTROL AND EXPERIMENTATION.

Ramón Cáceres
 Universidad de los Andes
 Facultad de Ingeniería
 Dpto. de Electrónica
 Mérida - Edo. Mérida - Venezuela.
 E-mail: rcaceres@ing.ula.ve
 eel3roc@ibm.ufsc.br
 Tel: 58-74-402907
 Fax: 58-74-402947

Ivo Barbi
 Federal University of Santa Catarina.
 Dpto. Electrical Engineering
 Power Electronics Institute (INEP)
 P.O.Box: 5119 (88040-970)
 Florianópolis - SC - Brazil
 E-mail: ivo@inep.ufsc.br
 Tel: 55-48231-9204
 Fax: 55-48-234-5422

Abstract - This paper proposes a new voltage source inverter referred to as boost inverter or boost DC - AC converter. The main attribute of the new inverter topology is the fact that it generates an AC output voltage larger than the DC input one, depending on the instantaneous duty - cycle. This property is not found in the classical voltage source inverter which produces an AC output instantaneous voltage always lower than the DC input voltage. Operation, analysis, modulation, control strategy and experimental results are included in this paper. The new inverter is intended to be used in UPS design, whenever an AC voltage larger than the DC link voltage is needed, with no need of a second power conversion stage.

I. INTRODUCTION

The conventional VSI (voltage source inverter) shown in Fig. 1, referred to as buck inverter in this paper, is probably the most important power converter topology. It is used in many distinct industrial and commercial applications. Among these applications, UPS and AC motor drives are the most important.

One of the characteristics of the buck inverter is that the instantaneous average output voltage is always lower than the input DC voltage.

As a consequence, when an output voltage larger than the input one is needed, a boost converter must be used between the DC source and the inverter, shown in Fig. 2.

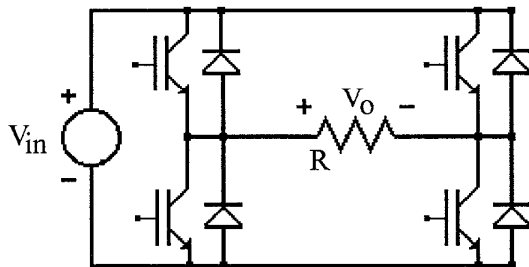

Fig. 1 The conventional voltage source inverter or buck inverter.

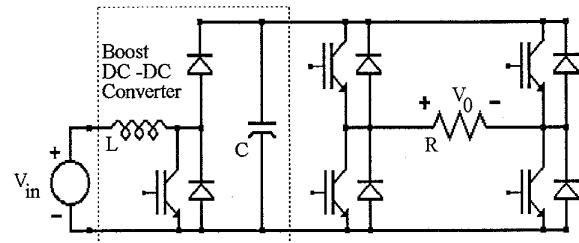

Fig. 2 Circuit used to generate an AC voltage larger than the DC input voltage.

Depending on the power and voltage levels involved, this solution can result in high volume, weight, cost and reduced efficiency.

In this paper a new voltage source inverter is proposed, referred to as boost inverter, which naturally generates an output AC voltage lower or larger than the input DC voltage depending on the duty - cycle. Details on analysis, control and experimentation are presented in the subsequent sections.

II. THE NEW INVERTER AND PRINCIPLE OF OPERATION

The proposed boost inverter achieves DC - AC conversion, as indicated in Fig. 3.

The blocks A and B represent DC to DC converters. These converters produce a DC - biased sine wave output, so that each source only produces an unipolar voltage. The modulation of each converter is 180 degrees out of phase with the other, which maximizes the voltage excursion across the load. The load is connected differentially across the converters. The problem of generating bipolar voltage at output is solved by a push-pull arrangement. Thus, converters realization need to be current bi-directional.

The proposed inverter is based on the boost converter. The current bi-directional boost converter is shown in Fig. 4.a. A circuit implementation of the boost DC to AC converter is shown in Fig. 4.b.

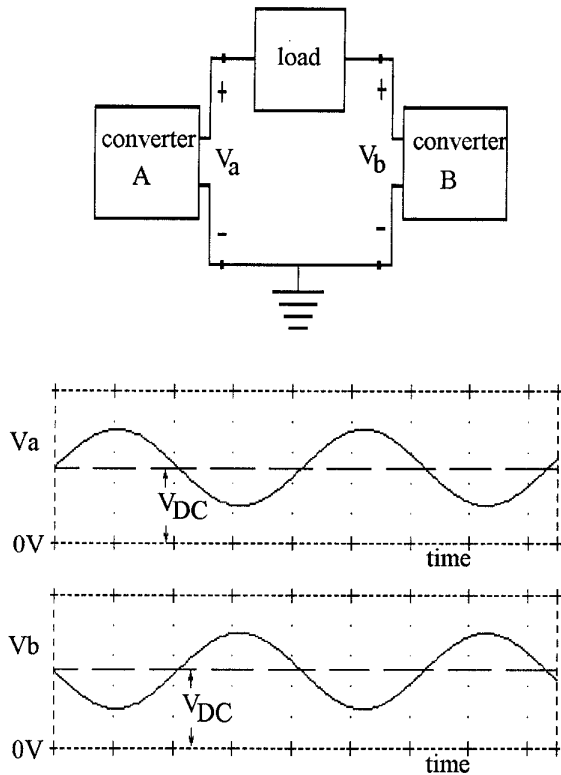

Fig. 3 A basic approach to achieve DC-to-AC conversion, with boost characteristics.

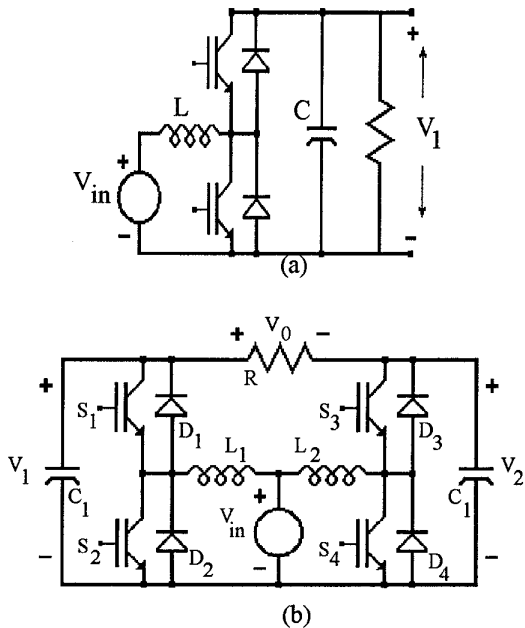

Fig. 4 (a) The current bi-directional boost converter and (b) The proposed DC - AC boost converter.

For a boost converter, by using the averaging concept, we obtain the following voltage relation for the continuous conduction mode:

$$\frac{V_1}{V_{in}} = \frac{1}{1-D} \quad (1)$$

where D is the duty cycle.

The voltage gain, for the boost inverter, can be derived as follows. Assume that the two converter are 180 degrees out of phase. Then, the output voltage can be obtained as:

$$V_o = V_1 - V_2 = \frac{V_{in}}{1-D} - \frac{V_{in}}{D} \quad (2)$$

$$\frac{V_o}{V_{in}} = \frac{2D-1}{D(1-D)} \quad (3)$$

The gain characteristic of the boost inverter is shown in Fig. 5. It is interesting to note that the feature of zero output voltage is obtained for $D = 0.5$. If the duty cycle is varied around this point, then there will be an AC output voltage across the output terminal.

III. - SMALL - SIGNAL MODELING AND CONTROL ASPECTS

The DC and small-signal performance of a boost DC to AC converter is determined simply by substituting the circuits models (point by point) by the PWM switch, and analyzing the resulting linear circuits [1], [2]. These circuit models are shown in Fig. 6 for the DC and fundamental frequency. After determination of the DC operating point, the control to output transfer function is obtained.

Fig. 7 shows the equivalent circuit for the boost inverter, with the three-terminal PWM switch.

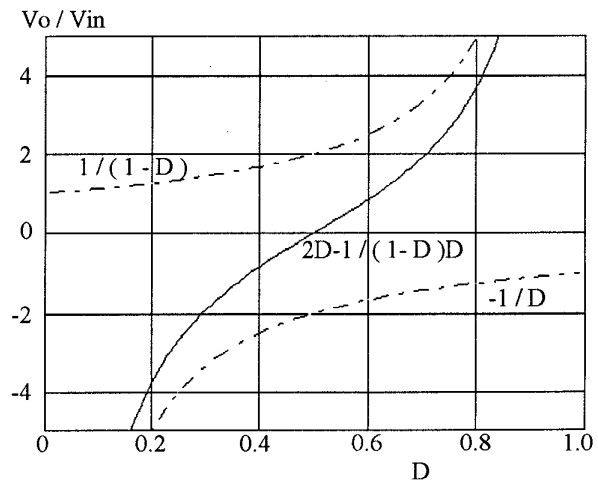
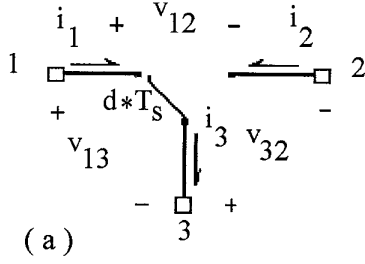
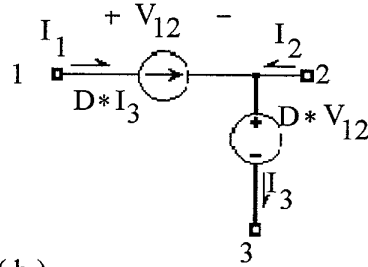

Fig. 5 DC gain characteristic.



(a)



(b)

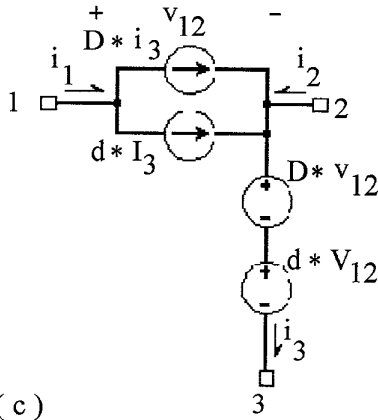

(c)

Fig. 6 (a) The PWM switch, (b) DC model and (c) Fundamental frequency model of the PWM switch.

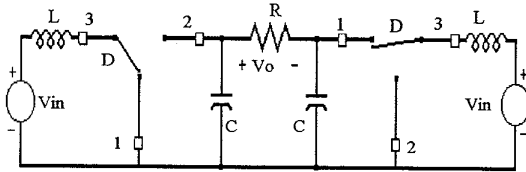

Fig. 7 The boost inverter showing the PWM switches.

A.- DC Analysis

By substitution of the DC model of the PWM switch into the boost inverter of Fig. 7, results in the circuit of Fig. 8. In this circuit all the reactive elements have been shorted or opened as required at zero frequency.

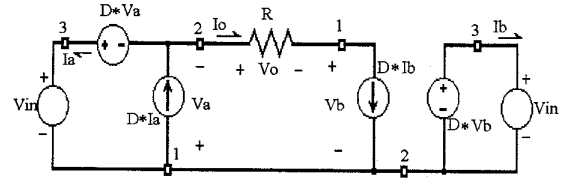

Fig. 8 DC model of the boost inverter.

Analyzing the circuit of the Fig. 8 we obtain the following equations:

$$V_a = \frac{-V_{in}}{1-D} \quad (4)$$

$$V_b = \frac{V_{in}}{D} \quad (5)$$

$$V_o = V_{in} \left(\frac{2D-1}{D(1-D)} \right) \quad (6)$$

$$I_a = -\frac{(2D-1)}{D(1-D)^2} \frac{V_{in}}{R} \quad (7)$$

$$I_b = -\frac{(2D-1)}{D^2(1-D)} \frac{V_{in}}{R} \quad (8)$$

B.- Control to output transfer function

Fig. 9 shows the fundamental frequency model. It is determined by substitution of the fundamental frequency model of the PWM switch into the boost inverter of Fig. 7. In this model, we are only considering perturbations in the duty cycle.

Analyzing the circuit of the Fig. 9 we obtain the following equations:

$$v_o = -v_a - v_b \quad (9)$$

$$-v_a = d [Z_a(S)] - v_o [Z_b(S)] \quad (10)$$

where,

$$Z_a(S) = \frac{I_a SL - V_a(1-D)}{(1-D)^2 + S^2 CL} \quad (11)$$

$$Z_b(S) = \frac{SL}{R((1-D)^2 + S^2 CL)} \quad (12)$$

$$v_b = v_o [Z_c(S)] - d [Z_d(S)] \quad (13)$$

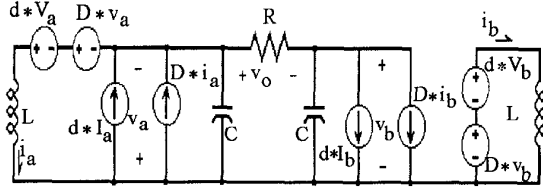

Fig. 9 Fundamental frequency model of the boost inverter.

$$Z_c(S) = \frac{1}{R(SC + D^2/SL)} \quad (14)$$

$$Z_d(S) = \frac{DV_b + SLI_b}{SL(SC + D^2/SL)} \quad (15)$$

By substitution of (10) and (13) into the (9), the control to output transfer function is obtained as:

$$\frac{v_o}{d} = R \frac{X_1 S^3 + X_2 S^2 + X_3 S + X_4}{Y_1 S^4 + Y_2 S^3 + Y_3 S^2 + Y_4 S + Y_5} \quad (16)$$

where,

$$X_1 = (I_a + I_b)CL^2 \quad (17)$$

$$X_2 = (DV_b - (1-D)V_a)CL \quad (18)$$

$$X_3 = (I_a D^2 + I_b(1-D)^2)L \quad (19)$$

$$X_4 = ((1-D)V_b - DV_a)(1-D)D \quad (20)$$

$$Y_1 = RC^2L^2 \quad (21)$$

$$Y_2 = 2CL^2 \quad (22)$$

$$Y_3 = RCL(1 - 2D + 2D^2) \quad (23)$$

$$Y_4 = L(1 - 2D + 2D^2) \quad (24)$$

$$Y_5 = RD^2(1 - D)^2 \quad (25)$$

C.- Frequency domain analysis of the inverter

Adopting the following component values: $L = 1.2$ mH, $C = 2$ μ F, $R = 60$ Ω and $V_{in} = 100$ V, the bode diagram of v_o/d can be obtained, using equation (16), as shown in Fig. 10.

For D greater than 0.5, using equation (16), the zeros locus of the open loop uncompensated system is in the right half plane, and the system will become unstable.

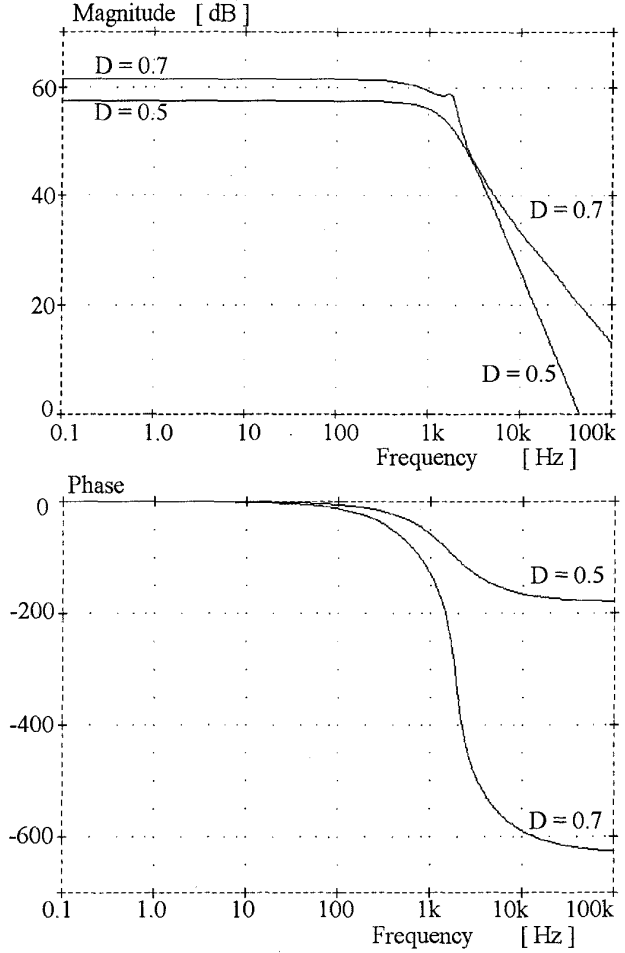

Fig. 10 Bode diagram of the open loop system, (for $D = 0.5$ and $D = 0.7$).

In order to make the output voltage pure sinusoidal, and to obtain global stability, a compensator should be employed in the system.

IV. SIMULATION AND EXPERIMENTAL RESULTS

In order to confirm the effective performance, key experiments were implemented with a 270 W prototype of the proposed converter shown in Fig. 4.b.

Input and output specifications are as follows:

Input $V_{in} = 96$ V

Output $V_o = 180 \cdot \sin(2\pi \cdot 60\text{Hz}) \cdot t$
 $f_s = 20$ kHz

The parameter of the circuits are as follow:

S1 - S4 : IRGBC20U (IGBT)

D1 - D4 : MUR850 (Diodes)

C1, C2 : 2 μ F each

L1, L2 : 1200 μ H each.

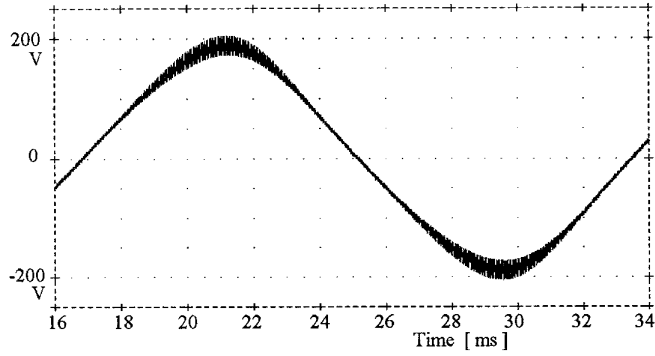

Fig 11. Output voltage.

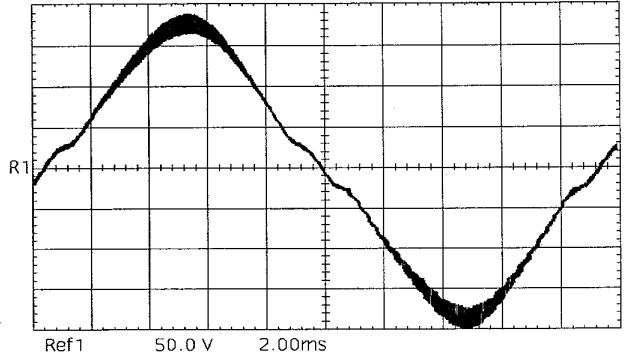

Fig 15 Output voltage

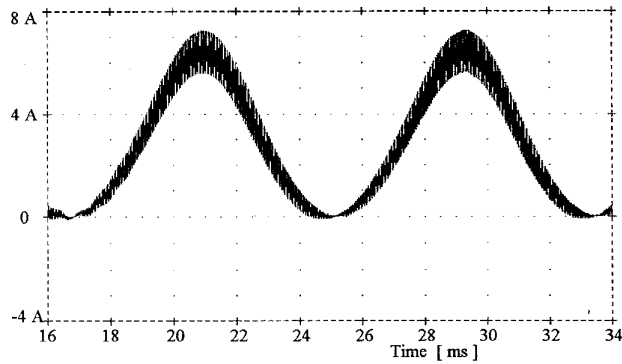

Fig 12 Current of the power supply.

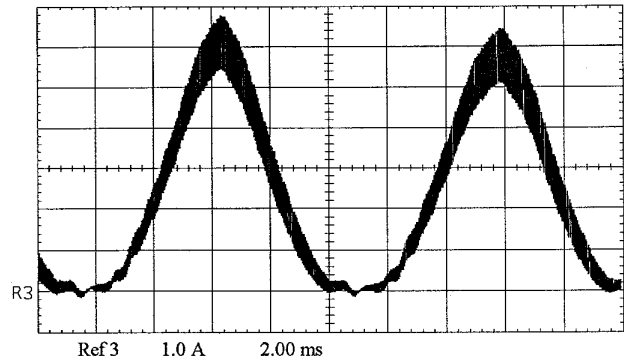

Fig 16 Current of the power supply.

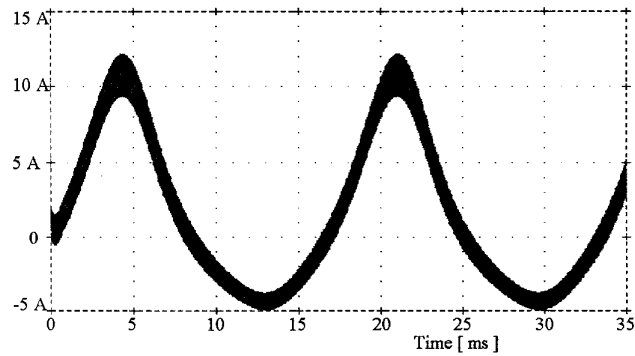

Fig 13 Current of the inductor L_1 .

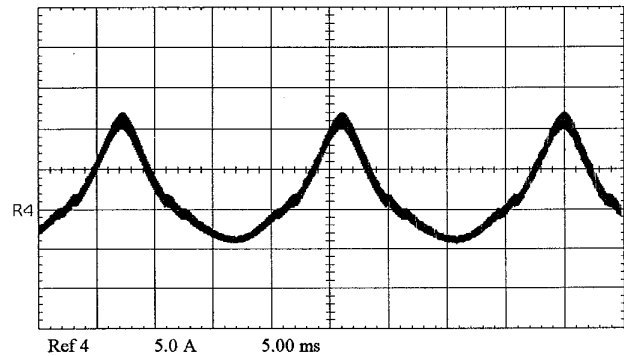

Fig 17 Current of the inductor L_1 .

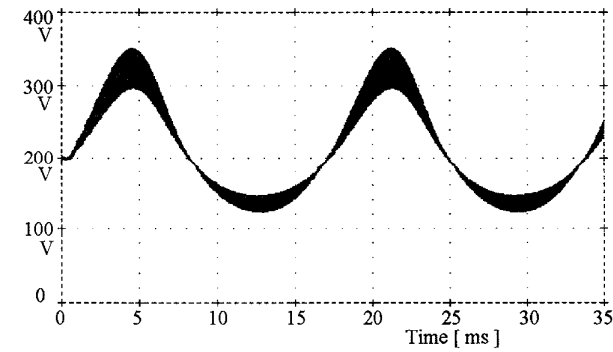

Fig 14 Voltage of the capacitor C_1 .

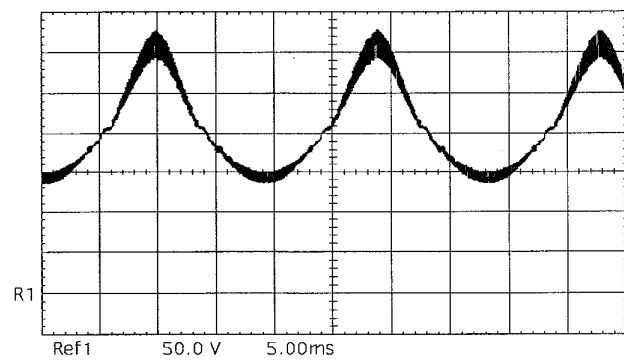

Fig 18 Voltage of the capacitor C_1 .

Using conventional controller (SN3525), PWM controller is implemented. It is easy to assemble a gate driver using isolation transformer because duty ratio is varied around 50 %.

Fig. 11, 12, 13 and 14 shows simulated waveforms of the converter for the open loop system and resistive load.

Fig. 15, 16, 17 and 18 illustrates observed waveforms of the converter for the open loop system. The experimental results are in good agreement with the simulation results.

In Fig. 14, for instance, the instantaneous AC voltage is 180 V, which means a rms value equal to 127V. The processed power is 270 W.

A simple compensator using an operational amplifier and RC network , shown in Fig. 19, is used to verify the response of the closed loop system.

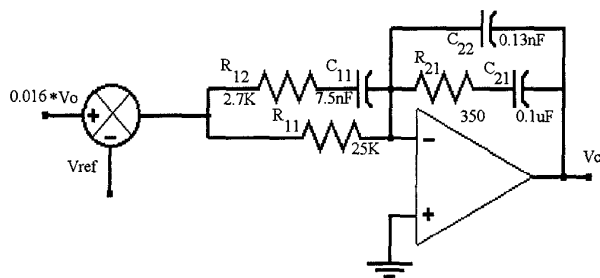

Fig. 19 The circuit diagram of the compensator.

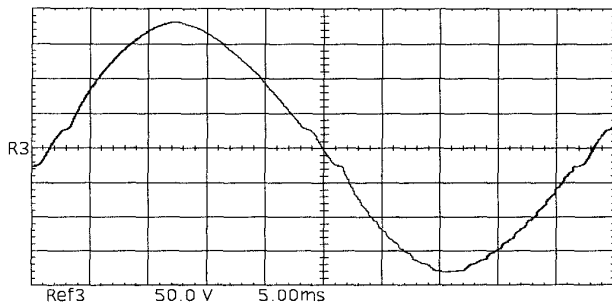

Fig. 20 Output Voltage with 20 Hz sinusoidal reference signal.

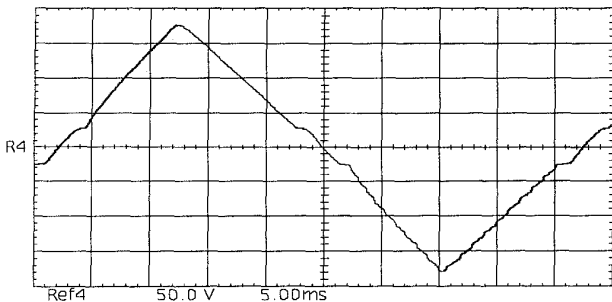

Fig. 21 Output Voltage with 20 Hz triangular reference signal.

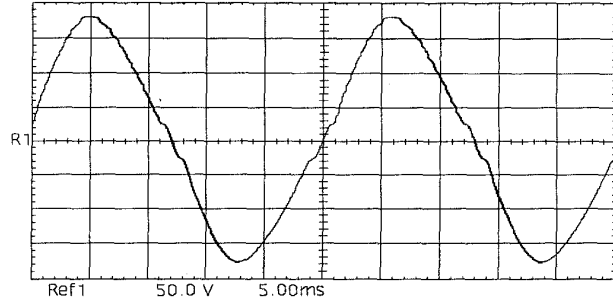

Fig. 22 Output Voltage with 40 Hz sinusoidal reference signal.

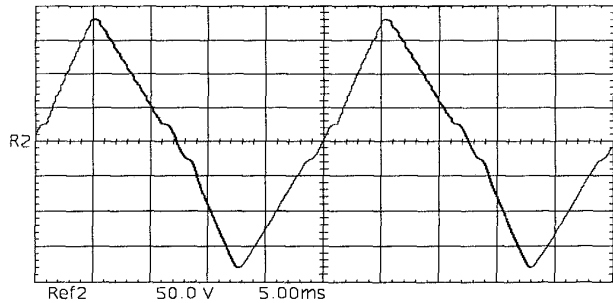

Fig. 23 Output Voltage with 40 Hz triangular reference signal.

Fig. 20, and 21 show experimental results for the closed loop system with a 20 Hz sinusoidal reference signal and 20 Hz triangular one, respectively. In Fig. 22 and 23 the frequency of reference signal is 40 Hz. In these last waveforms the switching component was filtered.

V. CONCLUSION

This paper presents a new type of DC - AC converter, referred to as boost inverter.

The active switches (IGBT's) are operated at a fixed frequency with the duty cycle around 50 %, which allows the use of a simple gate drive.

The circuit operation has been described and discussed. the effects are verified experimentally on a 270 W - 20 kHz breadboard.

The new inverter is applicable in UPS design, whenever a AC voltage larger than the DC link voltage is needed, with no need of a second power conversion stage.

VI. REFERENCES

- [1] V. Vorpérian, "Simplified Analysis of PWM Converters Using the Model of the PWM Switch Part I: Continuous Conduction", Proceeding of the VPEC seminar, Blacksburg, VA, pp 1-9, 1989.
- [2] R. Tymerski, V. Vorpérian, F.C. Lee and W. Baumann "Nonlinear Modelling of the PWM Switch" IEEE Power Electronics Specialists Conference 1988, pp 968 -976.